

Utilising Magnus Effect to Increase Downforce in Motorsport

By Mark Lin^{*}, Patrick Lewis[±] & Periklis Papadopoulos[°]

The Magnus effect is the generation of a sidewise force on a spinning cylindrical or spherical solid immersed in a fluid (liquid or gas) when there is relative motion between the spinning body and the fluid. This is most commonly seen in baseball, tennis, or European football where the ball's trajectory is curved due to its rotation. The idea of using the Magnus effect in an airfoil to produce lift was proposed in 1941 in a patent application by Massey. This is also known as Kutta–Joukowski lift, first analyzed by Kutta and Joukowski in the late 19th century. In maritime applications, it is known as Flettner rotor sails, first used in the 1920's. Although Magnus effect is not new, the idea of using it on a racecar wing to improve downforce has not been extensively studied. The concept is to replace the front leading-edge of the wing with a rotating cylinder of the same diameter to produce additional circulation around the foil. This idea was born out of discussion at San Jose State University's Formula SAE team as a way to create variable downforce on their wings. Although the idea was proposed but it was never built because of the complexity in the construction and a lack of rigorous analysis. Subsequently from our CFD simulation, it shows that by imposing a $+2U$ angular velocity to the front LE cap (i.e., rotating upwards in the negative-x direction), we could gain 4.25% of downforce. Since the leading edge cap is roughly cylindrical, physically replacing it by a cylinder would not cause a visible change to the race car's geometry while improving the aerodynamics using Magnus effect. This CFD data show promise to take the next step of building a physical prototype and perform aerodynamic experiments to validate this finding.

Keywords: Magnus effect, aerodynamics, downforce, CFD, motorsport.

Introduction

Magnus effect is a term used to describe the aerodynamic force imparted on an object while it is spinning. This in turn would affect the trajectory of the object. It is named after Heinrich Gustav Magnus, the German scientist who investigated it in the mid 1800's. One good example of the Magnus effect is a “curve ball” thrown by an American baseball pitcher. Why does the ball path curve? Because the ball is spinning. This IS the Magnus effect. Another good demonstration of this effect is the YouTube video by Veritasium (2015), which shows the distance travelled when a basketball is dropped from a tall dam with and without spin. We see this effect all

^{*}Principal Investigator, Lin Design Engineering, USA.

[±]Aerospace Engineer, Maxar Technologies, USA.

[°]Professor, San Jose State University, USA.

over sports every day, from European football to golf to volleyball. However, usage of the Magnus effect in other industries is less frequently seen. This paper studies the application of the Magnus effect to motorsport to further expand the automotive design envelope and performance. This is especially true in Formula racing, where a predefined formula homologates the design of the cars to ensure competition fairness. However, if the Magnus effect can be made to work it would be especially advantageous. This study investigates the idea using Computational Fluid Dynamics.

Literature Review

The first idea of utilising a rotating cylinder for the leading edge of an airfoil was seen in a 1944 patent by Massey. Figure 1 shows the patent drawing that illustrates the utility of such a device in aviation. Hence, the idea is not new as it has been proposed for use back in the 1940's.

Figure 1. 1944 US Patent of Magnus Effect on Airfoils

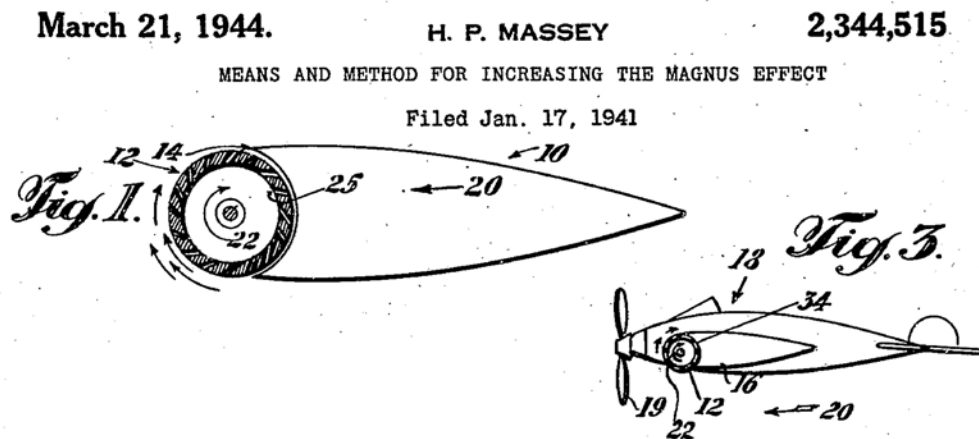

Subsequent to this proposal, the Magnus effect has not really been seen much in the aviation industry as noted by Seifert (2012). He commented while it has been used in the shipping industry, it has not really been adapted to the aeronautic industry. In recent years, a resurgence in using Magnus effect in aviation has resulted in YouTube videos, in particular the *KFC Bucket Aeroplane* (Sripol 2017) and another video about *Building an Advanced Magnus Effect Plane* from the UK (ProjectAir 2021). However, both videos use only RC radio-controlled models instead of full-scale implementation. As far as analysis goes, Dharmendra et al. (2021) and Patkunam et al. (2015) showed how Magnus effect can increase lift on an aircraft wing using CFD simulation. Another two papers that are more theoretical look specifically at the Magnus effect on a spinning cylinder (Gowree and Prince 2012, Stafy and Neto 2016). Overall, there has not been many publications showing practical aeronautical applications of the Magnus effect, whereas in marine applications commercial use of the Magnus effect is demonstrated in the

shipping industry as the Flettner Rotor (MarineInsight 2021). It was first used in maritime in the 1920's as shown in Figure 2.

Figure 2. *Flettner Rotor used in Maritime Applications*

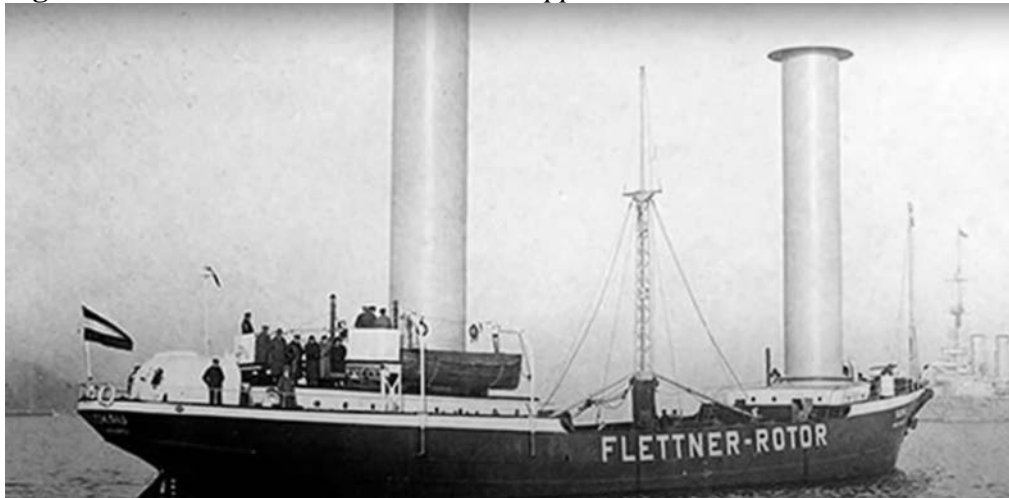

The idea of using Magnus effect for ship propulsion continues today with companies such as Norsepower Ltd. (2017) where large oceanliners are fitted with tall vertical cylinders. With these references, it is noteworthy that while there have been commercial demonstrations in the shipping and aviation industries, in the automotive industry it has only been discussed to some extent (Angiras et al. 2022, Saward 2012, Kamal et al. 2015) and no extensive fluid dynamic analyses as presented in this paper. Even though the Magnus effect has not seen wide commercial adaptation, we actually see its effect in sports every day. A paper by Lyu and Smith on The Reverse Magnus Effect in Golf Balls is a good experimental approach to relate the backspin of the golf ball to its trajectory (Lyu et al. 2020). By putting dimples on the golf ball they would induce turbulence and reduce wake. Another paper titled The Magnus Effect in Volleyball Service by Video Analysis (Martins et al. 2021) in the European Journal of Physics is also a good demonstration of the Magnus effect. Finally, a paper by Kenyon (2016) provides an attempt to derive equations for the Magnus effect using Bernoulli's equation. While it is a good approach, the derived formula would be limited because Bernoulli's equation is for inviscid flow while the Magnus effect is largely a viscous boundary layer phenomenon.

Methodology

To explore the Magnus effect for application in motorsport, first a design to implement the mechanism on a racecar wing needs to be proposed. This is to give a visual picture of how downforce can be generated using Magnus effect. Next, the aerodynamic behavior needs to be simulated using Computational Fluid Dynamics

to relate the mechanism's rotational velocity to the resulting downforce produced, which we will present in the results section.

A physical design is shown in Figure 3: instead of a wing with a fixed leading edge, it is replaced by a rotating cylinder mounted on bearings to the endplate on either ends. To drive the cylinder, a belt or a chain is looped around an electric motor mounted on the chassis. A more sophisticated implementation would be to hide the belt/chain inside the endplate using a cutout, since the endplate is typically made of sandwich material. However, for simplicity only this implementation is shown here.

Figure 3. Conceptual Design Illustrating Magnus Effect Implementation on Race Car Wing

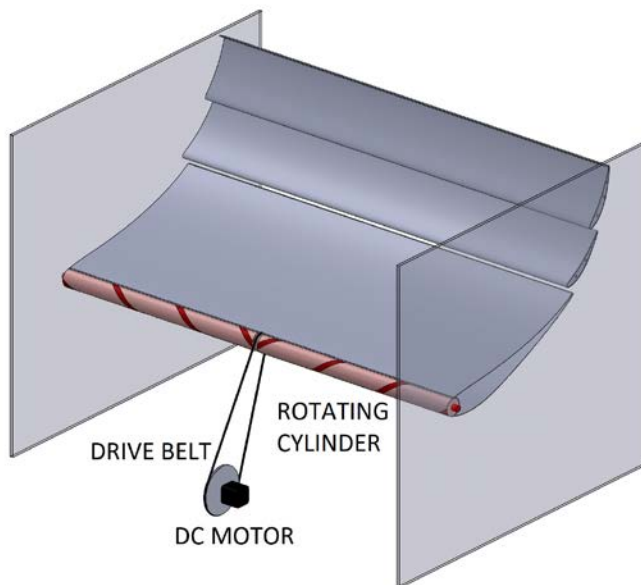

The foregoing paragraph describes an implementation of a Magnus effects wing in the physical form; to analyze it in CFD we need to idealize the geometry to have only a representation of the functional components. The geometry we choose to represent the wing and to analyze the Magnus effect is shown in Figure 4. This is a simple geometry that has 2 airfoils - a main element and a flap. On both ends is the vertical endplate. This geometry was used previously in a 2020 paper presented at the 4th ATINER Mechanical Engineering Conference. For this study we separate out the leading-edge caps so a moving boundary condition can be applied to simulate a rotating cylinder. For each leading-edge cap, a local coordinate system is defined for each cylindrical geometry to specify an angular velocity. Because the diameters of the two caps are different, each cylinder is specified with a different angular velocity so that the tangential velocity of the cylinder would be the same as the incoming fluid velocity, denoted by the symbol U . Before a volume mesh is generated, a thin surface inflation layer is prescribed to the wing's surface so that the boundary layer can be accurately modelled, because for Magnus effect it is all about the relative motion between the rotating surface and the adjacent fluid. In

CFD the boundary layer is modelled using the wall model (aka. law of the wall). After the fluid domain is meshed, it is solved using ANSYS Fluent.

Figure 4. Idealized CFD Model Used in Current Analysis

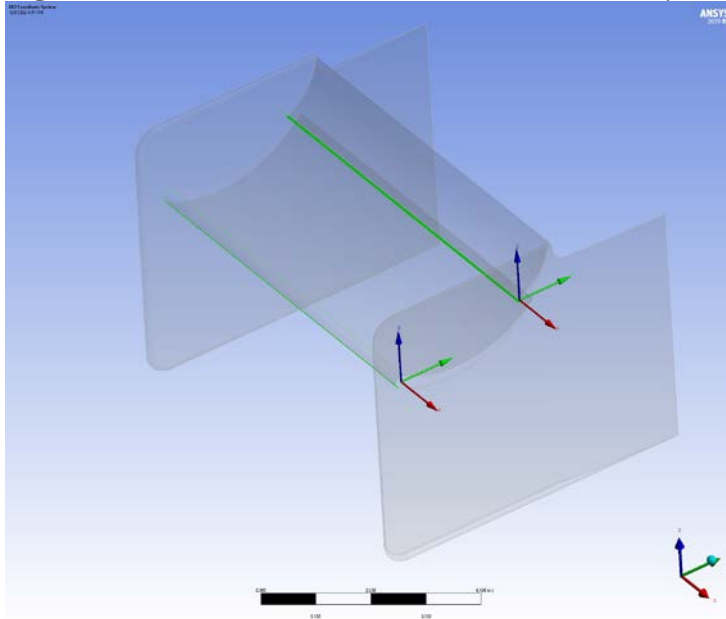

In the solver, boundary conditions are first applied to the mesh. For the two leading-edge caps: angular velocity (in rad/s), local coordinate frame, and axis of rotation are first specified. As will be seen, performing Magnus effect analysis is very simple in CFD because we only need to change the boundary specification from a stationary wall to a moving wall, and indicate the velocity as angular instead of linear; otherwise the mesh is exactly the same as a stationary wall case. In the analysis, we do not need to have a separate cylindrical geometry or a rotating/sliding mesh - one can simply achieve the same effect by changing the boundary condition. Since the free stream velocity (150 kph or 41.666 m/s) puts us in the turbulent flow regime, a turbulence model is used to simulate the flow for us to plot the pressure contour and streamlines. The turbulence model used is Transition SST (4 equations) to capture the transition from laminar to turbulent flow as air moves across the surfaces of the airfoil. The model is ran to 1000 iteration, where we have verified that the residuals have stabilized and the final solution is reached. Later on we will see, as the velocity is increased the solver will become unstable where the residuals will jump up (as in Figure 13), and if we continue to run the solver the solution will diverge and the run will terminate.

Results

The CFD model is ran with different rotational velocities from minus $2U$ (spinning down) to positive $2U$ (spinning up). “Spinning down” is counterclockwise rotation and “spinning up” is clockwise rotation viewed along the $-Z$ direction in

the local coordinates shown in Figure 4. The results are plotted in Figures 5 through 10. In each figure, the pressure contour in the fluid region and the corresponding streamlines are plotted. From the results one can see a progression from rotating the cylinder downwards to rotating it upwards. One thing to note when it's rotating downwards: the streamlines that originally went to the upper side of the leading edge is dragged down to the lower side because of the spinning of the cylinder. It actually creates a recirculation region on the topside of the leading edge. As the rotation is reversed toward the upper surface, the pressure contour shows a lower pressure region forming on the bottom of the leading edge, as shown by the second airfoil flap in Figure 9 and 10. Looking at Figures 5 through 10, while the leading edge rotation is changing rapidly, the changes in the pressure contour is minimal which makes it not suitable to decipher the Magnus effect at work; however, the change in the streamlines is more clear and one can associate the change in the rotational direction to how the air particles are moving, and whether they end up on the upperside or the lower side of the airfoil.

Figure 5. Pressure Contour and Streamlines for Down 2U Rotation

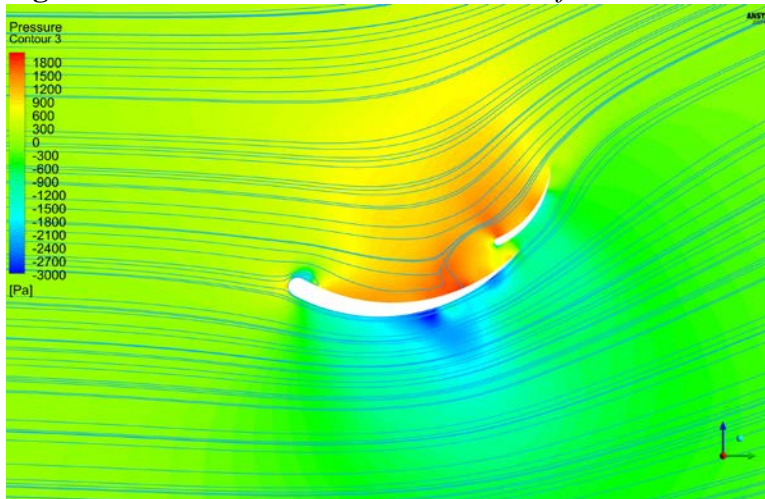

Figure 6. Pressure Contour and Streamlines for Down 1.5U Rotation

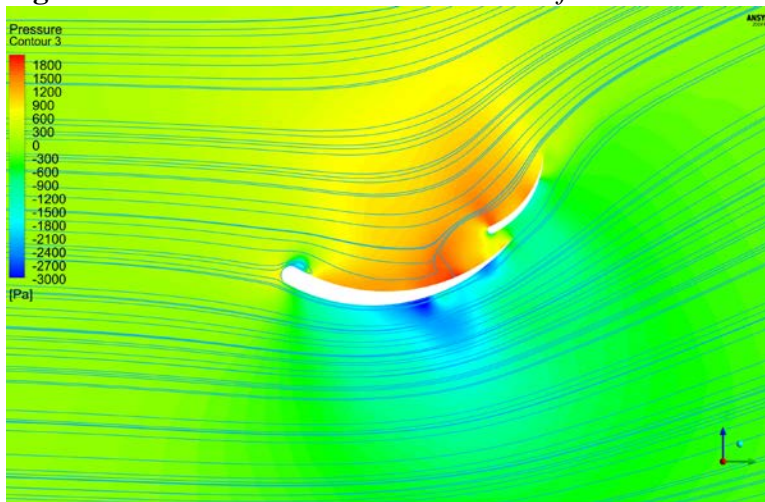

Figure 7. Pressure Contour and Streamlines for Down 1U Rotation

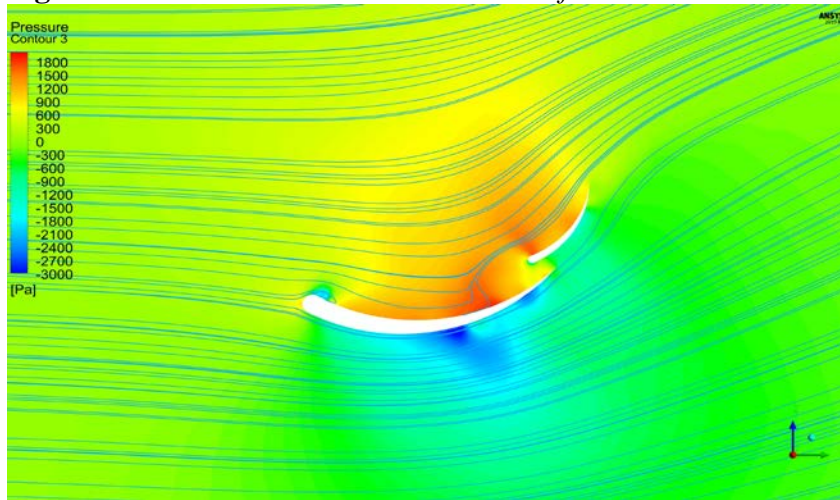

Figure 8. Pressure Contour and Streamlines for No Rotation

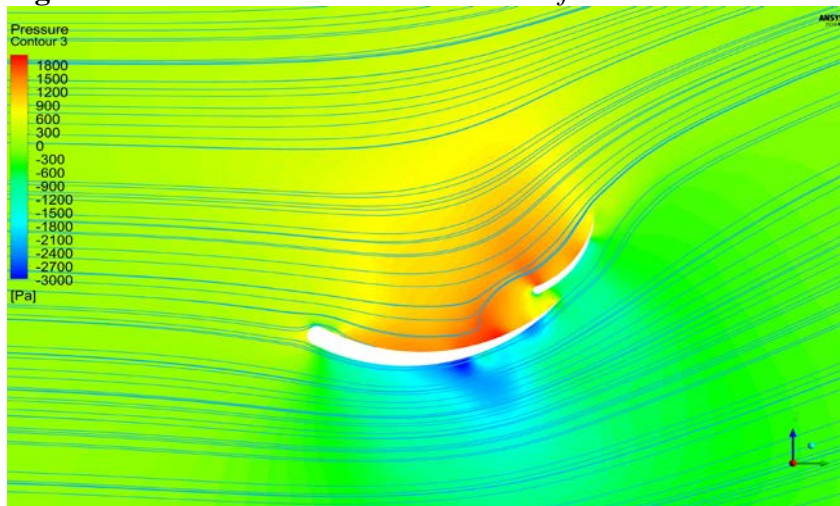

Figure 9. Pressure Contour and Streamlines for Up 1U Rotation

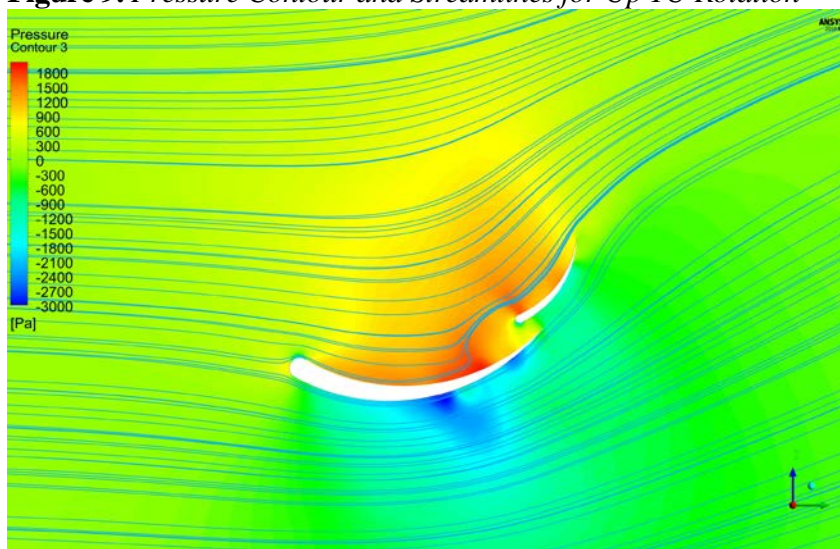

Figure 10. Pressure Contour and Streamlines for Up 2U Rotation

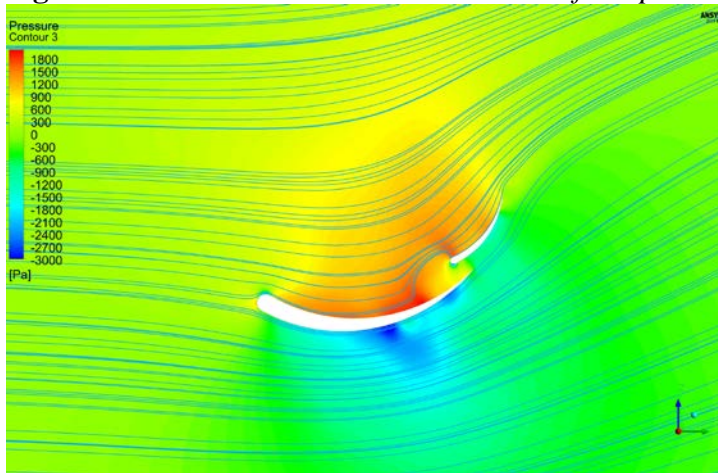
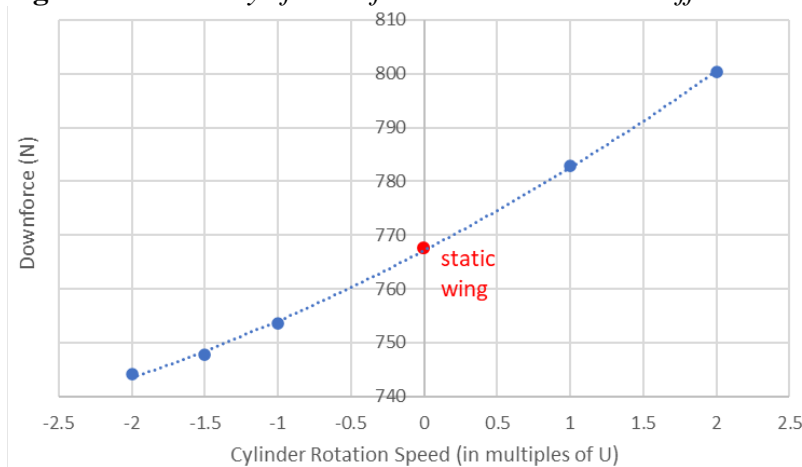

Figure 11 is a summary of the downforce predicted by the 6 cases shown in Figures 5-10. The downforce produced by these 6 cases is reported by CFD-POST in ANSYS Workbench. CFD-POST is the post processor for looking at CFD results. The downforce is obtained by going to the Calculators tab in CFD-POST and selecting *Function Calculator*. Next, *Force* is selected as the function and Z is selected as the direction. Finally, areas over the wing are selected individually and the results are summed together. The method by which it is obtained is to take the computed surface pressure, multiplies it by the surface area normal, and sums it over the entire surface. Each data point in Figure 11 represents an individual CFD run from a separate ANSYS Workbench project. When all the data are plotted together, it clearly shows a trend that when the cylinder is spinning upwards, more downforce is created on the wing. The baseline to which we are comparing this to is the wing with no motion, meaning without Magnus effect. In this plot, this shows that by spinning the cylinder upwards with a tangential velocity of 2U, meaning twice as fast as the freestream velocity, or twice the speed that the car is travelling, we can get a 4.25% increase in downforce. This is done with the same airfoil profile and will be unnoticeable to the untrained eyes.

Figure 11. Summary of Downforce Generated Over Different Rotation Speeds



Discussion

From these analytical results, let's explain what we are seeing using aerodynamic principles (Anderson 2011). One way to look at this is by looking at the boundary layer interaction between the wall surface and the free stream velocity. Using 3 cases as example: upward 1U rotation, no rotation, and downward 1U rotation. Figure 12 shows a schematic of these three cases. When there is no rotation fluid flow is equally parsed between the upperside and the lower side, with a stagnation point at the center of the radius. The boundary layer that develops is the same on both sides, by symmetry argument. Next, looking at the top schematic where the cylinder is spinning upwards with a velocity of 1U: now the top surface is moving at exactly the same speed as the freestream, therefore there is no relative motion between the surface and the fluid. Since wall shear stress is equal to the dynamic viscosity times the change of velocity in the y direction, which in this case is zero, the wall shear stress is zero on the top surface.

$$\tau = \mu \left(\frac{du}{dy} \right) \quad (1)$$

This means that the topside of the cylinder is in inviscid flow! Now flipping the direction of rotation to downward 1U and look at the bottom schematic: the lower side of the cylinder is now in inviscid flow. Next, let's look at the location of the stagnation point on the cylinder: if the cylinder is rotating upwards then the stagnation point moves down, indicating that more of the fluid goes to the topside of the cylinder; oppositely, when the cylinder is rotating downwards then the stagnation point moves up, indicating that more of the fluid goes to the bottom side of the cylinder. If we can use the spin of the cylinder to affect the amount of fluid going to the upper surface versus the lower surface of an airfoil, we will affect the amount of downforce that is created. This explains the Magnus effect at work on a racecar's wing.

Continue increasing the rotational velocity will eventually lead to solver instability as shown in Figure 13. This is a numerical problem and not a physical one. What it's telling us is that computationally the math has exceeded its limit so the solver cannot produce a reliable answer. In this situation, we refrain from drawing conclusions at the computational limit.

Figure 12. Schematics of Boundary Layer for Different Rotation Speeds

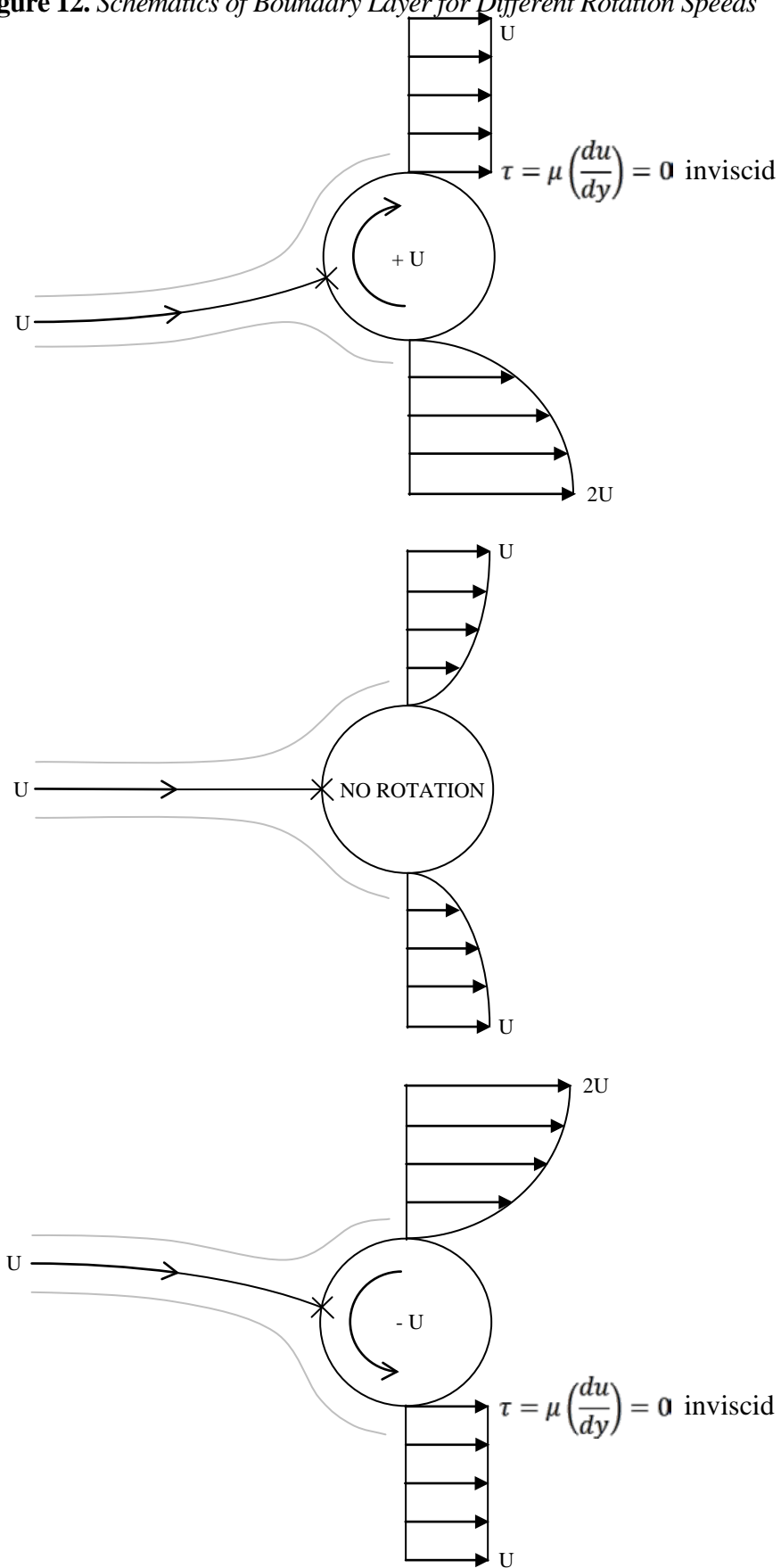
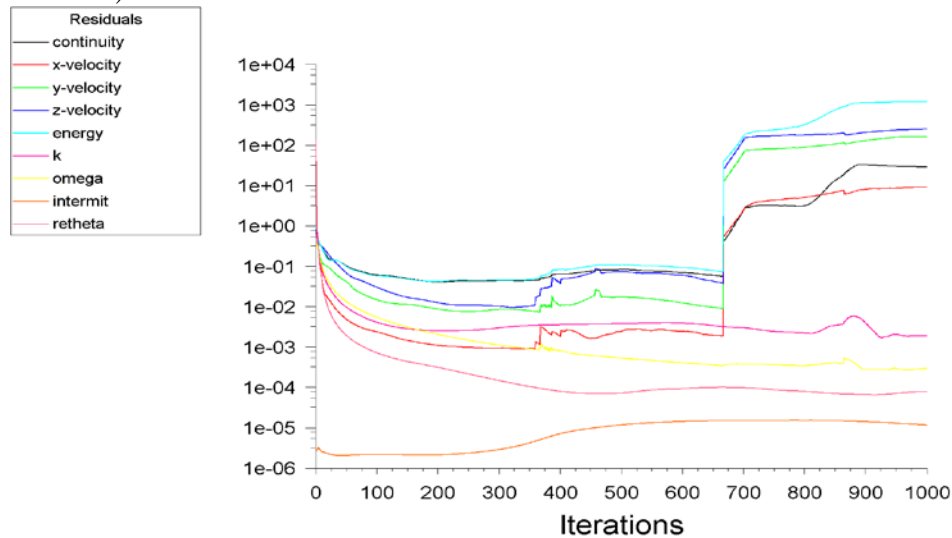

Figure 13. Residual Plot when Calculation Does Not Converge (Case: Up 3U Rotation)

Conclusions

Now that we have put forward an analysis utilising Computation Fluid Dynamics to illustrate the working of the Magnus effect, it is plausible that one can increase the amount of downforce on a racecar wing by imparting a rotational velocity on the leading edge with a cap cylinder. This is exactly the theory put forward in 1944 by Massey, albeit he did not have supporting data to show feasibility. This could be advantageous to racecars as each formula class has a prescribed geometry that the cars must conform to. With that said, there is currently no rule in the regulation that says the leading edge of the wing has to be stationary. And even if the homologation requires that, by rotating the cylinder at the same speed as the car, when the car is not moving the wing would also be stationary making it difficult to perceive a wing that incorporates Magnus effect. Some may argue that this gives an unfair advantage to the car that implements this device, but on the other hand advances in motorsport engineering often comes from innovations such as this. One should utilise the Magnus effect to increase downforce in motorsport.

Acknowledgments

The authors would like to thank San Jose State University's Aerospace Engineering Department and the College of Engineering's Formula SAE team for inspiration and support.

References

- Anderson JD Jr (2011) *Fundamental of aerodynamics*. 5th Edition. McGraw-Hill Series.
- Angiras V, Mishechkin M, Mularella J (2022) Utilizing the Magnus effect to produce more downforce than a standard wing. *Journal of Emerging Investigators* 5(15): 1–4.
- Dharmendra P, Sullad P, Mallapur N (2021) Study of Magnus effect using rotating cylinder on airfoil at different locations. *Journal of Aeronautics & Aerospace Engineering* 10(11).
- Gowree ER, Prince SA (2012) A computational study of the aerodynamics of a spinning cylinder in a crossflow of high Reynolds number. In *28th International Congress of the Aeronautical Sciences*, Brisbane, Australia, September 23-28.
- Kamal R, Socrates S, Kaliappan S (2015) Aerodynamic effects on formula one car using CFD. *International Journal of Applied Engineering Research* 10(33): 28164–28172.
- Kenyon KE (2016) On the Magnus effect. *Natural Science* 8(2): 49–52.
- Lyu B, Kensrud J, Smith L (2020) The reverse Magnus effect in golf balls. *Sports Engineering* 23(3).
- MarineInsight (2021) *Rotor sail explained*. YouTube Video. Available at: <https://www.youtube.com/watch?v=FJt8180kGTg>.
- Martins T, Bastos de Jesus VL, Sasaki DG (2021) The Magnus effect in volleyball service by video analysis. *European Journal of Physics* 43(1).
- Massey HP (1944) *Means and method for increasing the Magnus effect*. U.S. Patent 2,344,515.
- Norsepower Ltd (2017) *Norsepower rotor sail solution - long presentation video*. YouTube Video. Available at: https://www.youtube.com/watch?v=kDyBrSW1_Og.
- Patkunam K et al. (2015) Experimental study of Magnus effect over an aircraft wing, *International Journal of Research in Engineering and Technology* 4(10): 406–414.
- ProjectAir (2021) *Building an advanced Magnus effect plane*. YouTube Video. Available at: https://www.youtube.com/watch?v=UG2O_GK7-R8.
- Saward J (2012) *The secret of F1 aerodynamics in 2012*. JoeblogsF1. Available at: <https://joesaward.wordpress.com/2012/03/14/the-secret-of-f1-aerodynamics-in-2012>.
- Seifert J (2012) A review of the Magnus effect in Aeronautics. *Progress in Aerospace Sciences* 55(Nov): 17–45.
- Sripol P (2017) *RC KFC bucket aeroplane (Magnus effect)*. YouTube Video. Available at: <https://www.youtube.com/watch?v=K6geOms33Dk>.
- Stafy V, Neto AS (2016) Study about Magnus effect on spinning cylinders and its use on micro air vehicles. In *Proceedings of the XXXVII Iberian Latin-American Congress on Computational Methods in Engineering*, Brasilia, DF, Brazil, November 6-9.
- Veritasium (2015) *Backspin basketball flies off dam*. YouTube Video. Available at: <https://www.youtube.com/watch?v=2OSrvzNW9FE>.